

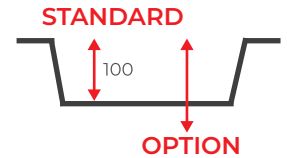

TRAYSEALER TSP 8

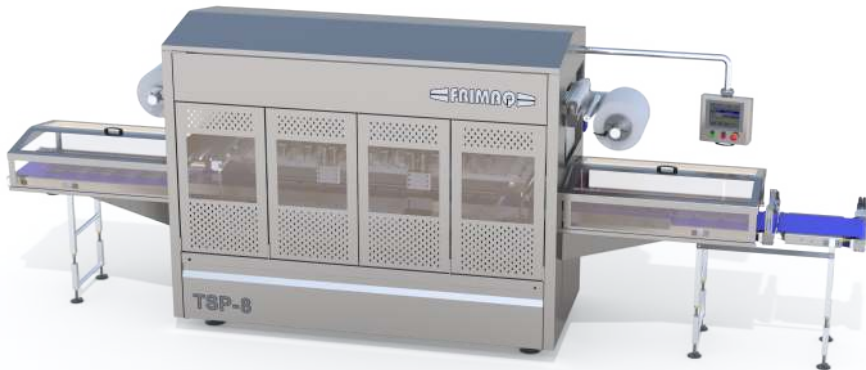

MOULDS SHELving OPTION

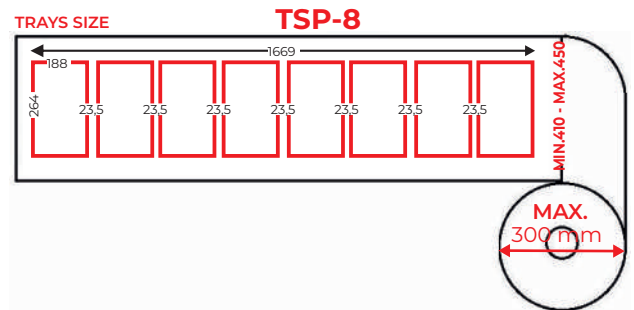
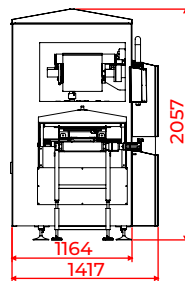
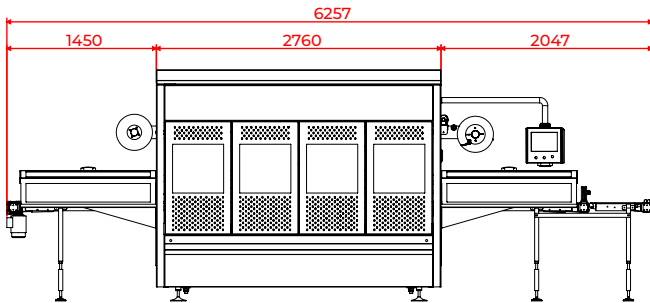
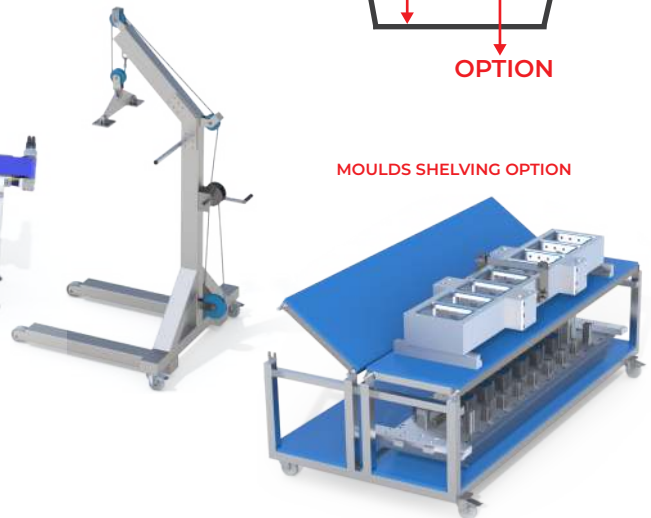
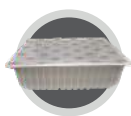

| | | | | |
|--|---|---|---|--|
| <p>ONLY SEALING OPTION</p>  | <p>VACUUM OPTION</p>  | <p>GAS-MAP OPTION</p>  | <p>TWO-LAYER SEALING OPTION</p>  | <p>GAS-MAP + VAP OPTION</p>  |
| <p>SKIN +0 OPTION</p>  | <p>SKIN +20 OPTION</p>  | <p>SKIN +60 OPTION</p>  | <p>SEALING +60 TS OPTION</p>  | |

FEATURES:

- Colour touchscreen panel 5.7".
- Structure in stainless steel aisi 304.
- Vacuum by mbars and time, or both.
- Gas injection by mbars and time over gas.
- Film dragging by two synchronized motors.
- Moulds adaptation chosen by the customer.
- Replaceable rings to adapt the tray to every manufacturer.
- Film progress mode: by length- by printed stain.
- Trays dragging by clamps.
- Power: ____ kw (according to the pumps).