

# TRAYSEALER TSP 6

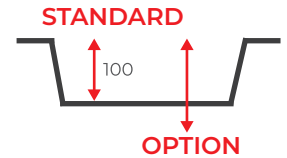

MOULDS SHELIVING OPTION

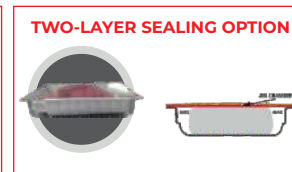
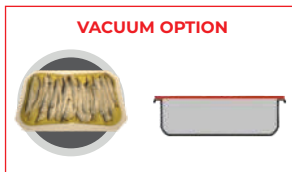
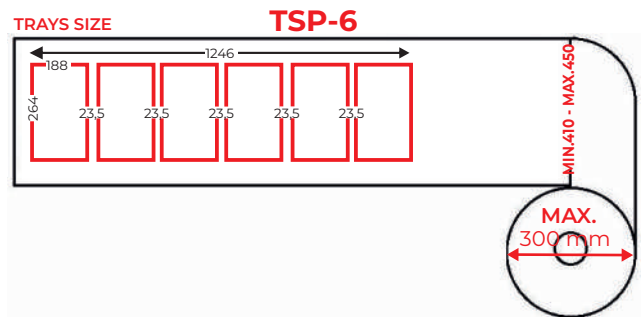
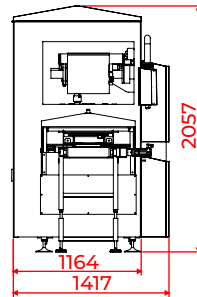
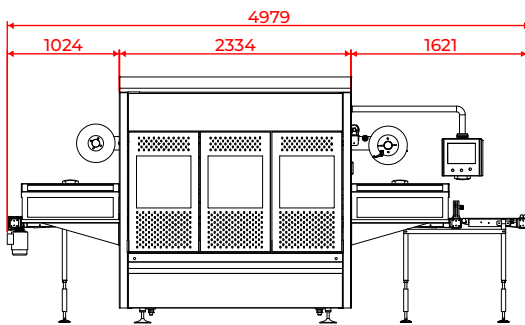
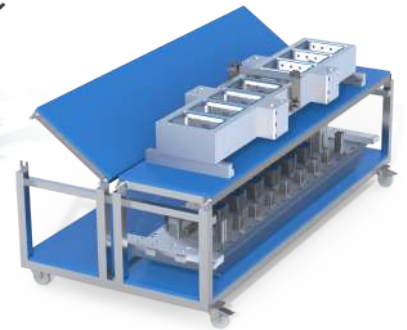

## FEATURES:

- Colour touchscreen panel 5.7".
- Structure in stainless steel aisi 304.
- Vacuum by mbars and time, or both.
- Gas injection by mbars and time over gas.
- Film dragging by two synchronized motors.
- Moulds adaptation chosen by the customer.
- Replaceable rings to adapt the tray to every manufacturer.
- Film progress mode: by length-by printed stain.
- Trays dragging by clamps.
- Power: \_\_\_\_ kw (according to the pumps).