

TRAYSEALER MODEL MAXI SKIN +40

SKIN +0

SKIN +20

SKIN +40

SKIN +20
FLAT CARDBOARD

SKIN +40
FLAT CARDBOARD

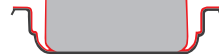

MOULD 1/2 GN

MOULD 1/4 GN

MOULD 1/8 GN

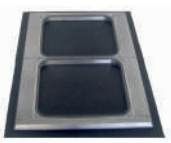

OPTION
UPWINDER

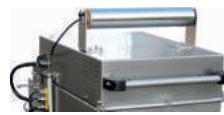

STANDARD

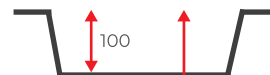

OPTION



PUMP
OUT THE MACHINE

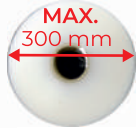

CUTTING BLADE MEASURES

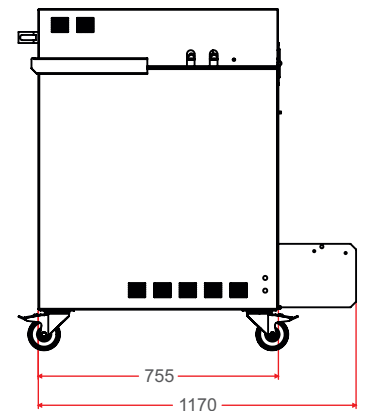
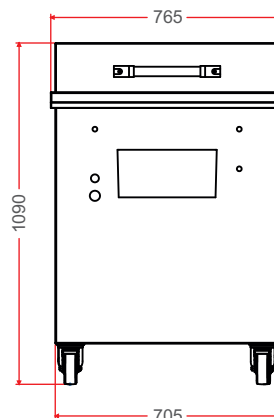
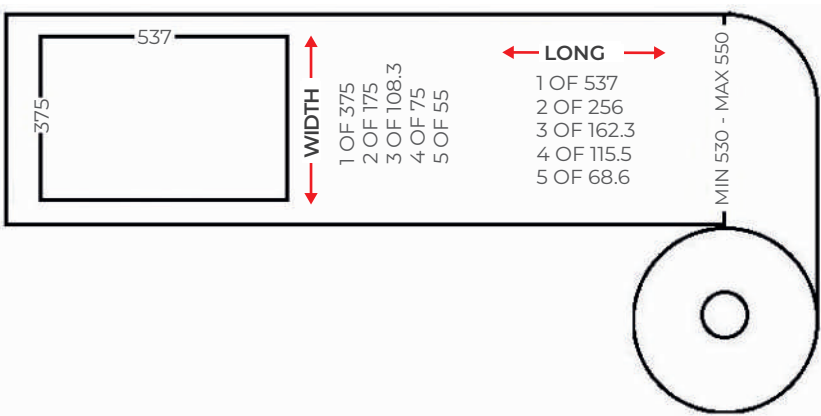

FEATURES:

- Structure in stainless steel AISI 304.
- Touchscreen with 25 programs to be accommodated to different products.
- Vacuum by millibars and time, or both.
- Temperature control probe.
- Manual lowering of the hood.
- Busch vacuum pump 100 m³/h.

- Capacity for 1 tray 1 GN.
- Capacity for 2 trays ½ GN.
- Capacity for 4 trays ¼ GN.
- Capacity for 6 trays 1/6 GN.
- Capacity for 8 trays 1/8 GN.
- Capacity for 4 cardboards 190 x 260 mm.
- Or the model chosen by the customer.

- Film width: 520 mm.
- Cutting of the trays independently.
- Three phases 380v. 3P+N+T.
- Power 5000 W.
- Connected to the compressed air network.
- Compressed air consumption: 290 liters/minute/6 bars of pressure.